

DATA SHEET



PCA82C250 CAN controller interface

Product specification
Supersedes data of 1997 Oct 21
File under Integrated Circuits, IC18

2000 Jan 13

تهیه و توزیع قطعات الکترونیک

CAN controller interface

PCA82C250

FEATURES

- Fully compatible with the "ISO 11898" standard
- High speed (up to 1 Mbaud)
- Bus lines protected against transients in an automotive environment
- Slope control to reduce Radio Frequency Interference (RFI)
- Differential receiver with wide common-mode range for high immunity against ElectroMagnetic Interference (EMI)
- Thermally protected
- Short-circuit proof to battery and ground
- Low-current standby mode
- An unpowered node does not disturb the bus lines
- At least 110 nodes can be connected.

APPLICATIONS

- High-speed applications (up to 1 Mbaud) in cars.

GENERAL DESCRIPTION

The PCA82C250 is the interface between the CAN protocol controller and the physical bus. The device provides differential transmit capability to the bus and differential receive capability to the CAN controller.

QUICK REFERENCE DATA

SYMBOL	PARAMETER	CONDITIONS	MIN.	MAX.	UNIT
V _{CC}	supply voltage		4.5	5.5	V
I _{CC}	supply current	standby mode	–	170	μA
1/t _{bit}	maximum transmission speed	non-return-to-zero	1	–	Mbaud
V _{CAN}	CANH, CANL input/output voltage		–8	+18	V
V _{diff}	differential bus voltage		1.5	3.0	V
t _{PD}	propagation delay	high-speed mode	–	50	ns
T _{amb}	ambient temperature		–40	+125	°C

ORDERING INFORMATION

TYPE NUMBER	PACKAGE		
	NAME	DESCRIPTION	CODE
PCA82C250	DIP8	plastic dual in-line package; 8 leads (300 mil)	SOT97-1
PCA82C250T	SO8	plastic small outline package; 8 leads; body width 3.9 mm	SOT96-1
PCA82C250U	–	bare die; 2790 × 1780 × 380 μm	–

تهیه و توزیع قطعات الکترونیک

CAN controller interface

PCA82C250

BLOCK DIAGRAM

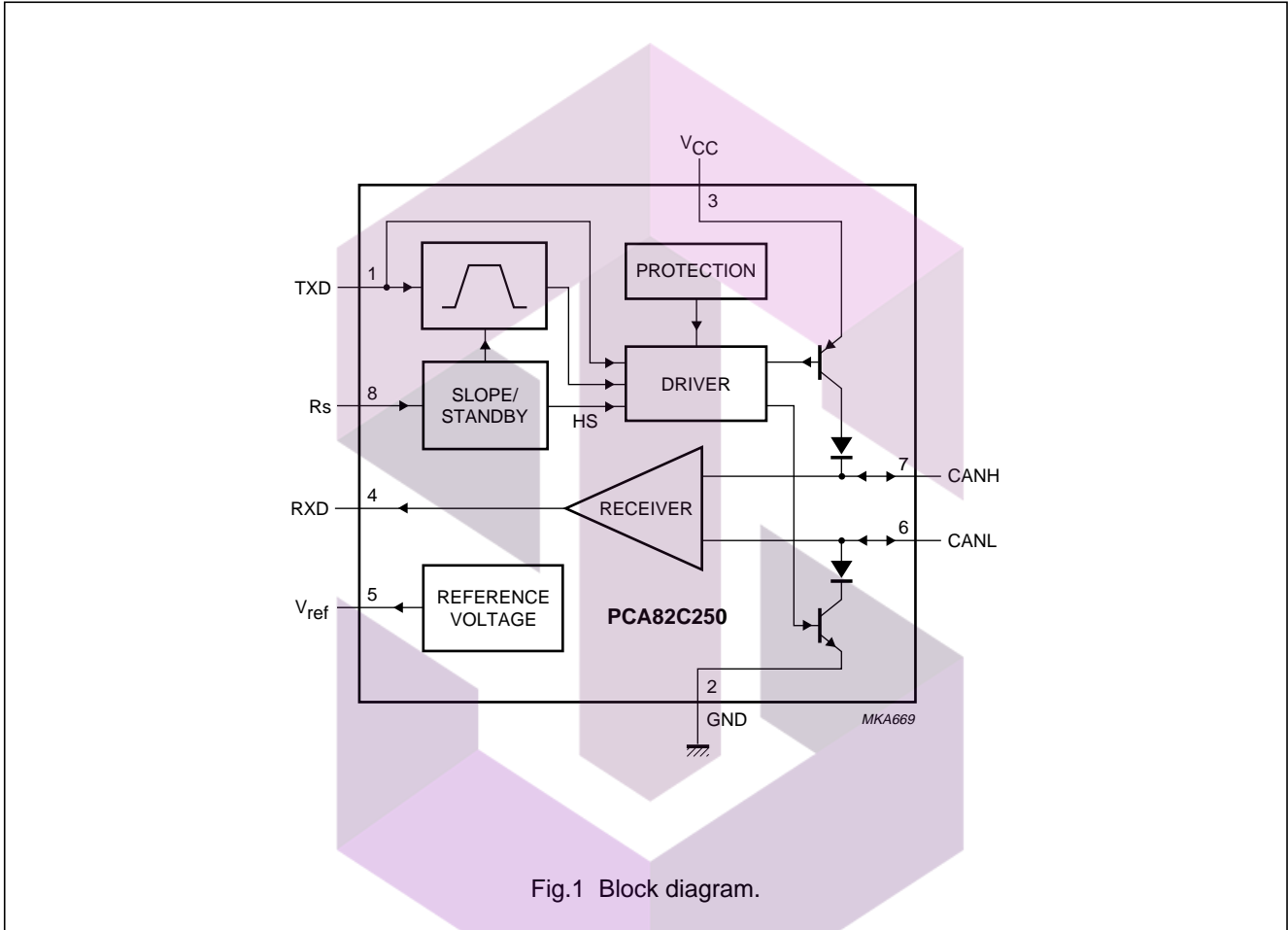

PINNING

SYMBOL	PIN	DESCRIPTION
TXD	1	transmit data input
GND	2	ground
V _{CC}	3	supply voltage
RXD	4	receive data output
V _{ref}	5	reference voltage output
CANL	6	LOW-level CAN voltage input/output
CANH	7	HIGH-level CAN voltage input/output
Rs	8	slope resistor input

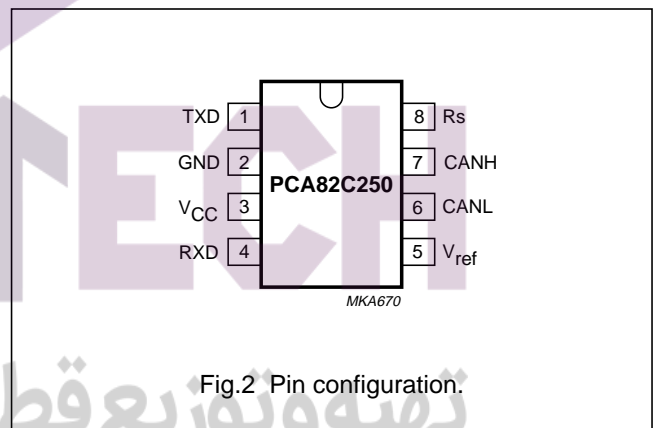

CAN controller interface

PCA82C250

FUNCTIONAL DESCRIPTION

The PCA82C250 is the interface between the CAN protocol controller and the physical bus. It is primarily intended for high-speed applications (up to 1 Mbaud) in cars. The device provides differential transmit capability to the bus and differential receive capability to the CAN controller. It is fully compatible with the "ISO 11898" standard.

A current limiting circuit protects the transmitter output stage against short-circuit to positive and negative battery voltage. Although the power dissipation is increased during this fault condition, this feature will prevent destruction of the transmitter output stage.

If the junction temperature exceeds a value of approximately 160 °C, the limiting current of both transmitter outputs is decreased. Because the transmitter is responsible for the major part of the power dissipation, this will result in a reduced power dissipation and hence a lower chip temperature. All other parts of the IC will remain in operation. The thermal protection is particularly needed when a bus line is short-circuited.

The CANH and CANL lines are also protected against electrical transients which may occur in an automotive environment.

Pin 8 (Rs) allows three different modes of operation to be selected: high-speed, slope control or standby.

For high-speed operation, the transmitter output transistors are simply switched on and off as fast as possible. In this mode, no measures are taken to limit the rise and fall slope. Use of a shielded cable is recommended to avoid RFI problems. The high-speed mode is selected by connecting pin 8 to ground.

For lower speeds or shorter bus length, an unshielded twisted pair or a parallel pair of wires can be used for the bus. To reduce RFI, the rise and fall slope should be limited. The rise and fall slope can be programmed with a resistor connected from pin 8 to ground. The slope is proportional to the current output at pin 8.

If a HIGH level is applied to pin 8, the circuit enters a low current standby mode. In this mode, the transmitter is switched off and the receiver is switched to a low current. If dominant bits are detected (differential bus voltage >0.9 V), RXD will be switched to a LOW level. The microcontroller should react to this condition by switching the transceiver back to normal operation (via pin 8). Because the receiver is slow in standby mode, the first message will be lost.

Table 1 Truth table of the CAN transceiver

SUPPLY	TXD	CANH	CANL	BUS STATE	RXD
4.5 to 5.5 V	0	HIGH	LOW	dominant	0
4.5 to 5.5 V	1 (or floating)	floating	floating	recessive	1
<2 V (not powered)	X ⁽¹⁾	floating	floating	recessive	X ⁽¹⁾
2 V < V _{CC} < 4.5 V	>0.75V _{CC}	floating	floating	recessive	X ⁽¹⁾
2 V < V _{CC} < 4.5 V	X ⁽¹⁾	floating if V _{Rs} > 0.75V _{CC}	floating if V _{Rs} > 0.75V _{CC}	recessive	X ⁽¹⁾

Note

1. X = don't care.

Table 2 Pin Rs summary

CONDITION FORCED AT PIN Rs	MODE	RESULTING VOLTAGE OR CURRENT AT PIN Rs
V _{Rs} > 0.75V _{CC}	standby	I _{Rs} < 10 μA
-10 μA < I _{Rs} < -200 μA	slope control	0.4V _{CC} < V _{Rs} < 0.6V _{CC}
V _{Rs} < 0.3V _{CC}	high-speed	I _{Rs} < -500 μA

CAN controller interface

PCA82C250

LIMITING VALUES

In accordance with the Absolute Maximum Rating System (IEC 60134); all voltages are referenced to pin 2; positive input current.

SYMBOL	PARAMETER	CONDITIONS	MIN.	MAX.	UNIT
V_{CC}	supply voltage		-0.3	+9.0	V
V_n	DC voltage at pins 1, 4, 5 and 8		-0.3	$V_{CC} + 0.3$	V
$V_{6,7}$	DC voltage at pins 6 and 7	$0\text{ V} < V_{CC} < 5.5\text{ V}$; no time limit	-8.0	+18.0	V
V_{trt}	transient voltage at pins 6 and 7	see Fig.8	-150	+100	V
T_{stg}	storage temperature		-55	+150	°C
T_{amb}	ambient temperature		-40	+125	°C
T_{vj}	virtual junction temperature	note 1	-40	+150	°C
V_{esd}	electrostatic discharge voltage	note 2	-2000	+2000	V
		note 3	-200	+200	V

Notes

- In accordance with "IEC 60747-1". An alternative definition of virtual junction temperature is:
 $T_{vj} = T_{amb} + P_d \times R_{th(j-a)}$, where $R_{th(j-a)}$ is a fixed value to be used for the calculation of T_{vj} . The rating for T_{vj} limits the allowable combinations of power dissipation (P_d) and ambient temperature (T_{amb}).
- Classification A: human body model; C = 100 pF; R = 1500 Ω ; V = ± 2000 V.
- Classification B: machine model; C = 200 pF; R = 25 Ω ; V = ± 200 V.

THERMAL CHARACTERISTICS

SYMBOL	PARAMETER	CONDITIONS	VALUE	UNIT
$R_{th(j-a)}$	thermal resistance from junction to ambient	in free air		
	PCA82C250		100	K/W
	PCA82C250T		160	K/W

QUALITY SPECIFICATION

According to "SNW-FQ-611 part E".



تهیه و توزیع قطعات الکترونیک

CAN controller interface

PCA82C250

CHARACTERISTICS

$V_{CC} = 4.5$ to 5.5 V; $T_{amb} = -40$ to $+125$ °C; $R_L = 60$ Ω; $I_b > -10$ μA; unless otherwise specified; all voltages referenced to ground (pin 2); positive input current; all parameters are guaranteed over the ambient temperature range by design, but only 100% tested at $+25$ °C.

SYMBOL	PARAMETER	CONDITIONS	MIN.	TYP.	MAX.	UNIT
Supply						
I_3	supply current	dominant; $V_1 = 1$ V	–	–	70	mA
		recessive; $V_1 = 4$ V; $R_8 = 47$ kΩ	–	–	14	mA
		recessive; $V_1 = 4$ V; $V_8 = 1$ V	–	–	18	mA
		standby; $T_{amb} < 90$ °C; note 1	–	100	170	μA
DC bus transmitter						
V_{IH}	HIGH-level input voltage	output recessive	$0.7V_{CC}$	–	$V_{CC} + 0.3$	V
V_{IL}	LOW-level input voltage	output dominant	–0.3	–	$0.3V_{CC}$	V
I_{IH}	HIGH-level input current	$V_1 = 4$ V	–200	–	+30	μA
I_{IL}	LOW-level input current	$V_1 = 1$ V	–100	–	–600	μA
$V_{6,7}$	recessive bus voltage	$V_1 = 4$ V; no load	2.0	–	3.0	V
I_{LO}	off-state output leakage current	-2 V < (V_6, V_7) < 7 V	–2	–	+1	mA
		-5 V < (V_6, V_7) < 18 V	–5	–	+12	mA
V_7	CANH output voltage	$V_1 = 1$ V	2.75	–	4.5	V
V_6	CANL output voltage	$V_1 = 1$ V	0.5	–	2.25	V
$\Delta V_{6,7}$	difference between output voltage at pins 6 and 7	$V_1 = 1$ V	1.5	–	3.0	V
		$V_1 = 1$ V; $R_L = 45$ Ω; $V_{CC} \geq 4.9$ V	1.5	–	–	V
		$V_1 = 4$ V; no load	–500	–	+50	mV
I_{sc7}	short-circuit CANH current	$V_7 = -5$ V; $V_{CC} \leq 5$ V	–	–	–105	mA
		$V_7 = -5$ V; $V_{CC} = 5.5$ V	–	–	–120	mA
I_{sc6}	short-circuit CANL current	$V_6 = 18$ V	–	–	160	mA
DC bus receiver: $V_1 = 4$ V; pins 6 and 7 externally driven; -2 V < (V_6, V_7) < 7 V; unless otherwise specified						
$V_{diff(r)}$	differential input voltage (recessive)		–1.0	–	+0.5	V
		-7 V < (V_6, V_7) < 12 V; not standby mode	–1.0	–	+0.4	V
$V_{diff(d)}$	differential input voltage (dominant)		0.9	–	5.0	V
		-7 V < (V_6, V_7) < 12 V; not standby mode	1.0	–	5.0	V
$V_{diff(hys)}$	differential input hysteresis	see Fig.5	–	150	–	mV
V_{OH}	HIGH-level output voltage (pin 4)	$I_4 = -100$ μA	$0.8V_{CC}$	–	V_{CC}	V
V_{OL}	LOW-level output voltage (pin 4)	$I_4 = 1$ mA	0	–	$0.2V_{CC}$	V
		$I_4 = 10$ mA	0	–	1.5	V
R_i	CANH, CANL input resistance		5	–	25	kΩ

CAN controller interface

PCA82C250

SYMBOL	PARAMETER	CONDITIONS	MIN.	TYP.	MAX.	UNIT
R_{diff}	differential input resistance		20	–	100	$k\Omega$
C_i	CANH, CANL input capacitance		–	–	20	pF
C_{diff}	differential input capacitance		–	–	10	pF
Reference output						
V_{ref}	reference output voltage	$V_8 = 1\text{ V};$ $-50\ \mu\text{A} < I_5 < 50\ \mu\text{A}$	$0.45V_{CC}$	–	$0.55V_{CC}$	V
		$V_8 = 4\text{ V};$ $-5\ \mu\text{A} < I_5 < 5\ \mu\text{A}$	$0.4V_{CC}$	–	$0.6V_{CC}$	V
Timing (see Figs 4, 6 and 7)						
t_{bit}	minimum bit time	$V_8 = 1\text{ V}$	–	–	1	μs
t_{onTXD}	delay TXD to bus active	$V_8 = 1\text{ V}$	–	–	50	ns
t_{offTXD}	delay TXD to bus inactive	$V_8 = 1\text{ V}$	–	40	80	ns
t_{onRXD}	delay TXD to receiver active	$V_8 = 1\text{ V}$	–	55	120	ns
t_{offRXD}	delay TXD to receiver inactive	$V_8 = 1\text{ V}; V_{CC} < 5.1\text{ V};$ $T_{amb} < +85\text{ }^\circ\text{C}$	–	82	150	ns
		$V_8 = 1\text{ V}; V_{CC} < 5.1\text{ V};$ $T_{amb} < +125\text{ }^\circ\text{C}$	–	82	170	ns
		$V_8 = 1\text{ V}; V_{CC} < 5.5\text{ V};$ $T_{amb} < +85\text{ }^\circ\text{C}$	–	90	170	ns
		$V_8 = 1\text{ V}; V_{CC} < 5.5\text{ V};$ $T_{amb} < +125\text{ }^\circ\text{C}$	–	90	190	ns
t_{onRXD}	delay TXD to receiver active	$R_8 = 47\text{ k}\Omega$	–	390	520	ns
		$R_8 = 24\text{ k}\Omega$	–	260	320	ns
t_{offRXD}	delay TXD to receiver inactive	$R_8 = 47\text{ k}\Omega$	–	260	450	ns
		$R_8 = 24\text{ k}\Omega$	–	210	320	ns
$ SR $	differential output voltage slew rate	$R_8 = 47\text{ k}\Omega$	–	14	–	$\text{V}/\mu\text{s}$
t_{WAKE}	wake-up time from standby (via pin 8)		–	–	20	μs
t_{dRXDL}	bus dominant to RXD LOW	$V_8 = 4\text{ V};$ standby mode	–	–	3	μs
Standby/slope control (pin 8)						
V_8	input voltage for high-speed		–	–	$0.3V_{CC}$	V
I_8	input current for high-speed	$V_8 = 0\text{ V}$	–	–	–500	μA
V_{stb}	input voltage for standby mode		$0.75V_{CC}$	–	–	V
I_{slope}	slope control mode current		–10	–	–200	μA
V_{slope}	slope control mode voltage		$0.4V_{CC}$	–	$0.6V_{CC}$	V

Note

1. $I_1 = I_4 = I_5 = 0\text{ mA}; 0\text{ V} < V_6 < V_{CC}; 0\text{ V} < V_7 < V_{CC}; V_8 = V_{CC}.$

CAN controller interface

PCA82C250

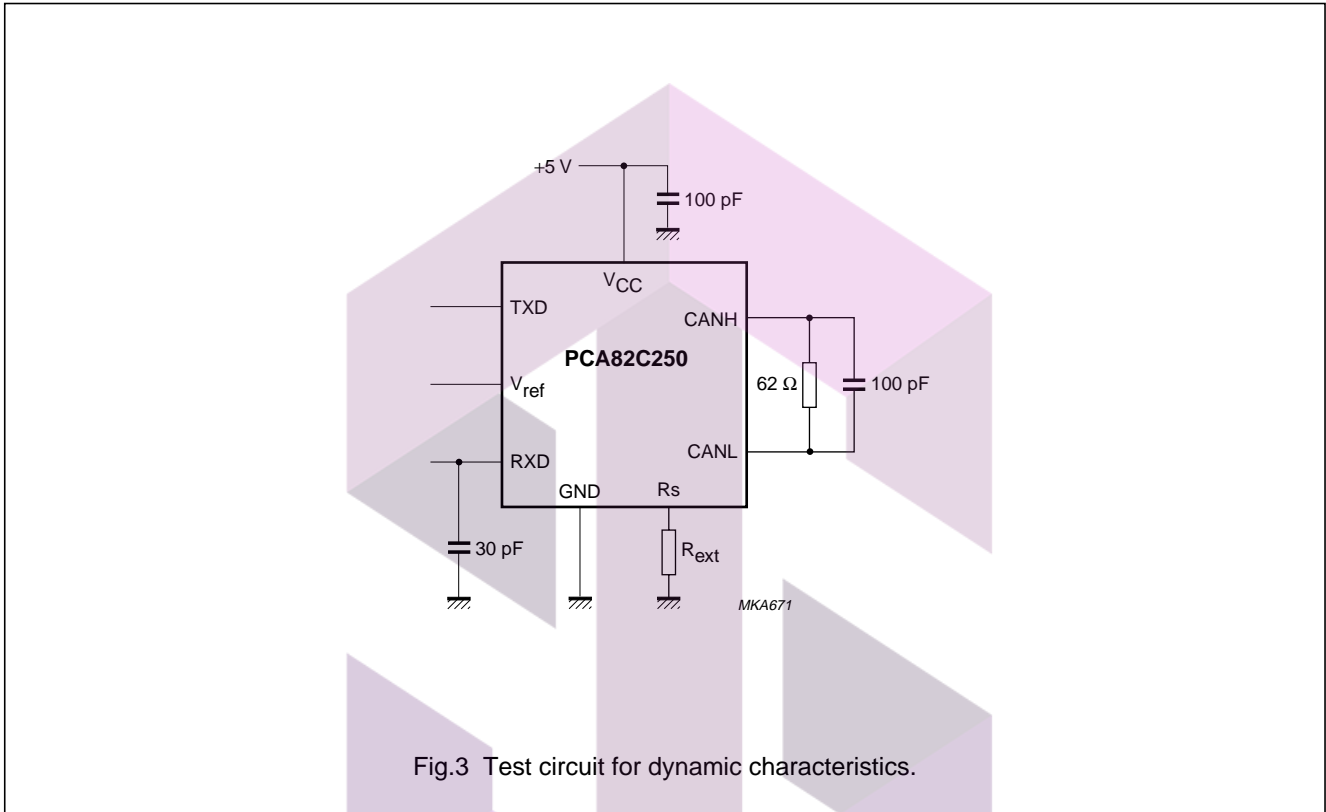

Fig.3 Test circuit for dynamic characteristics.

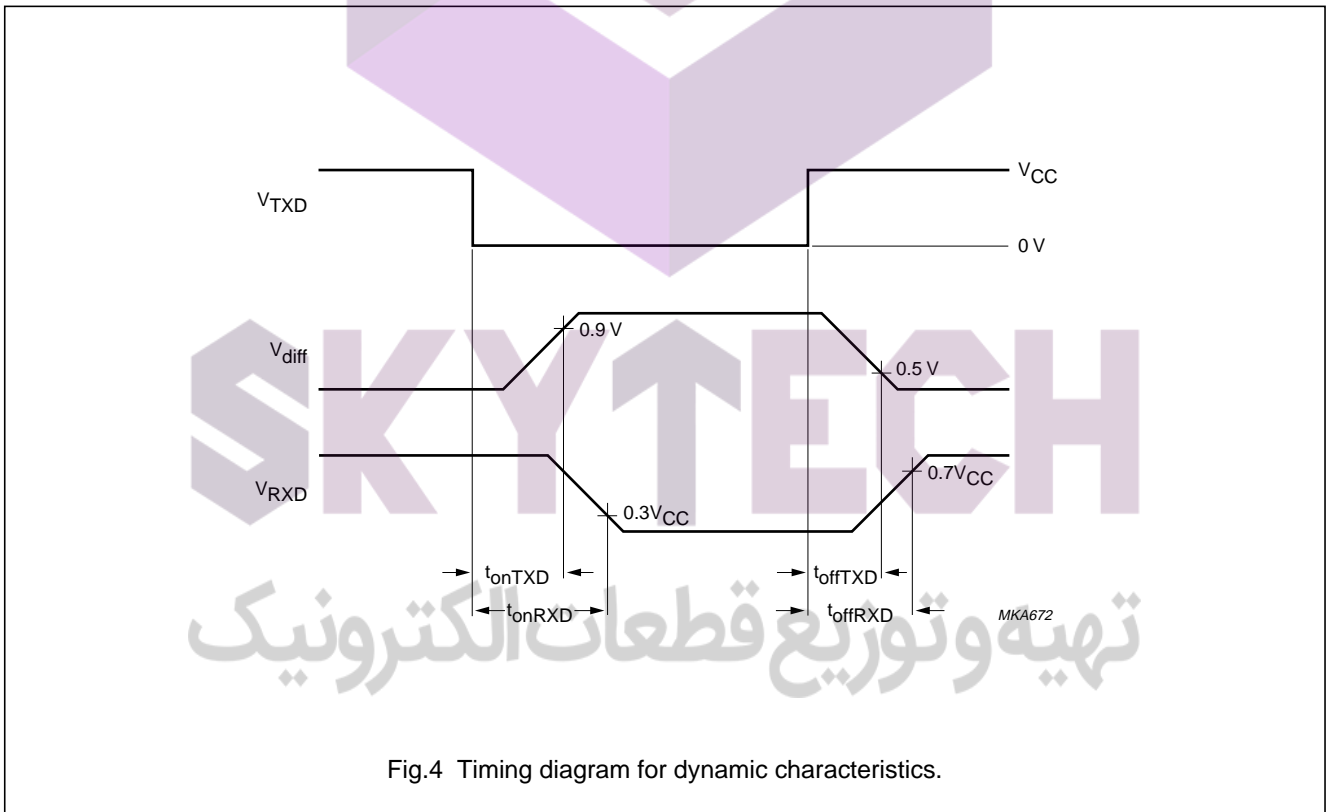

Fig.4 Timing diagram for dynamic characteristics.

CAN controller interface

PCA82C250

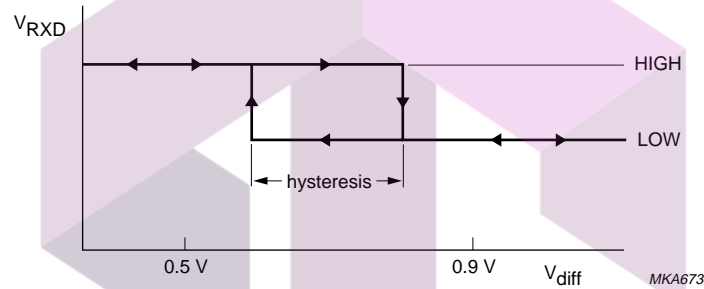
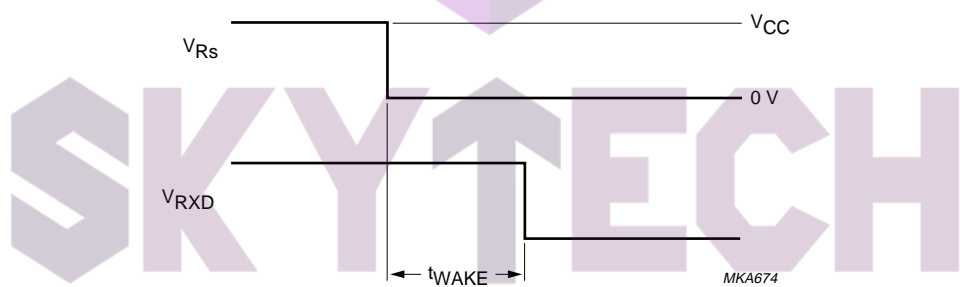

Fig.5 Hysteresis.



$V_1 = 1 V.$

Fig.6 Timing diagram for wake-up from standby.

CAN controller interface

PCA82C250

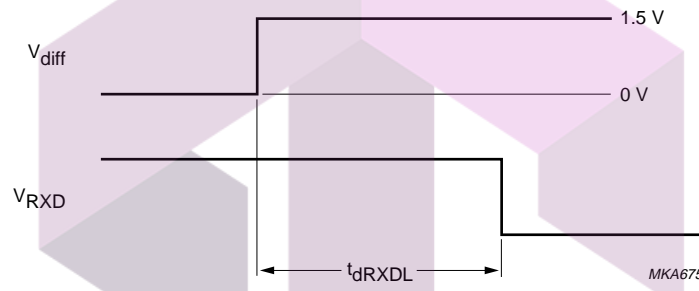

$V_1 = 4\text{ V}; V_8 = 4\text{ V}.$

Fig.7 Timing diagram for bus dominant to RXD LOW.

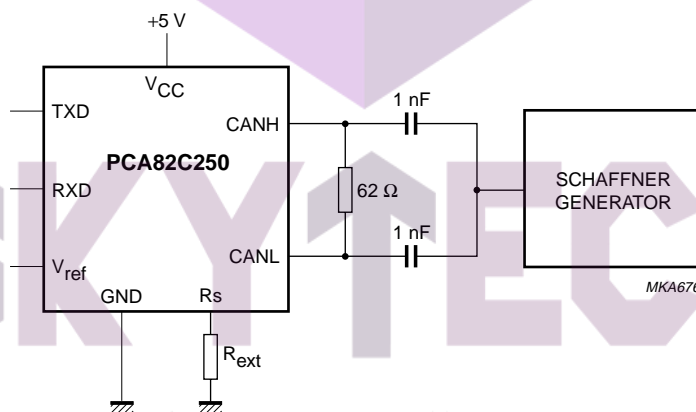

The waveforms of the applied transients shall be in accordance with "ISO 7637 part 1", test pulses 1, 2, 3a and 3b.

Fig.8 Test circuit for automotive transients.

CAN controller interface

PCA82C250

APPLICATION INFORMATION

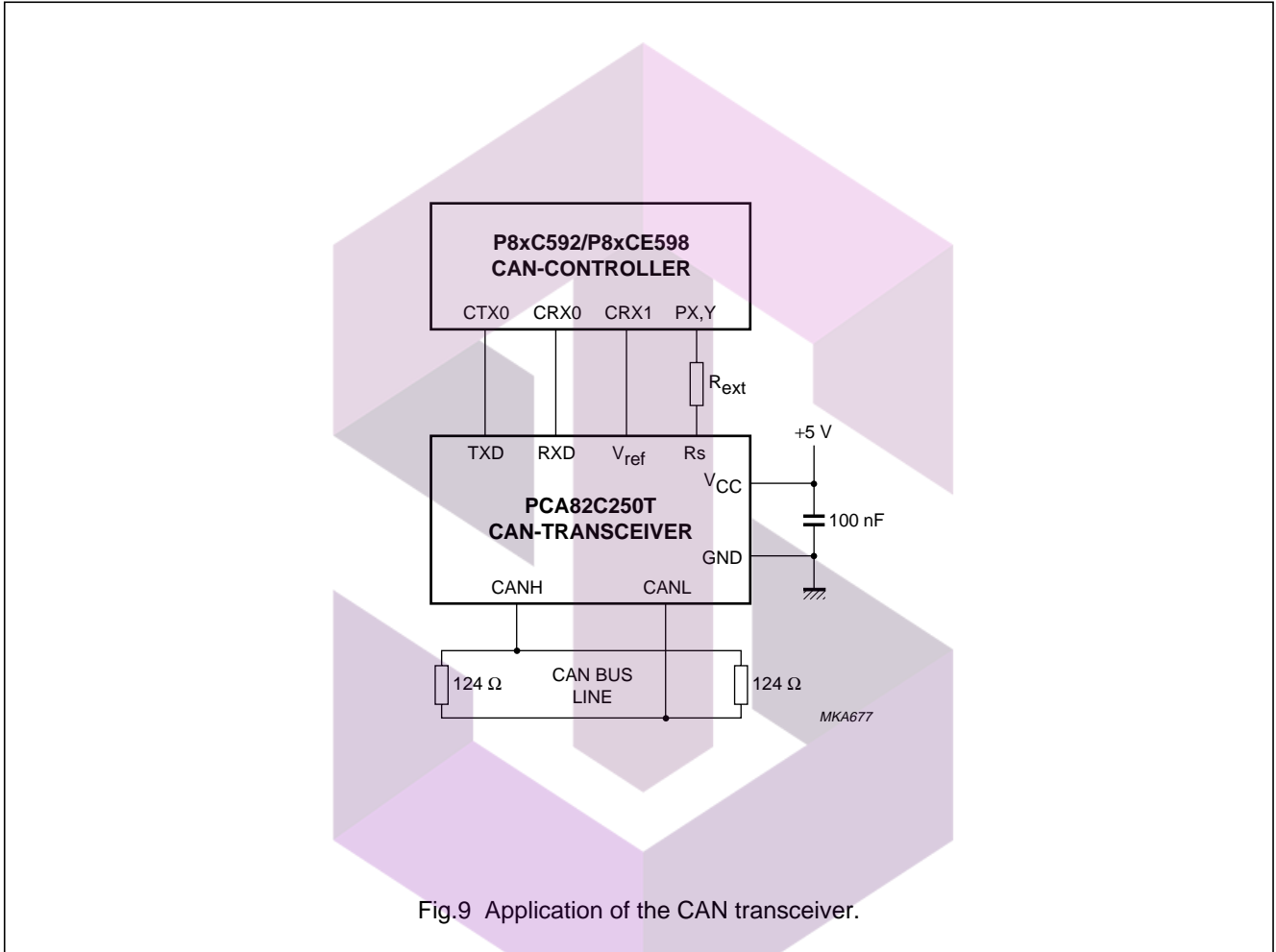

Fig.9 Application of the CAN transceiver.

SKYTECH

تهیه و توزیع قطعات الکترونیک

CAN controller interface

PCA82C250

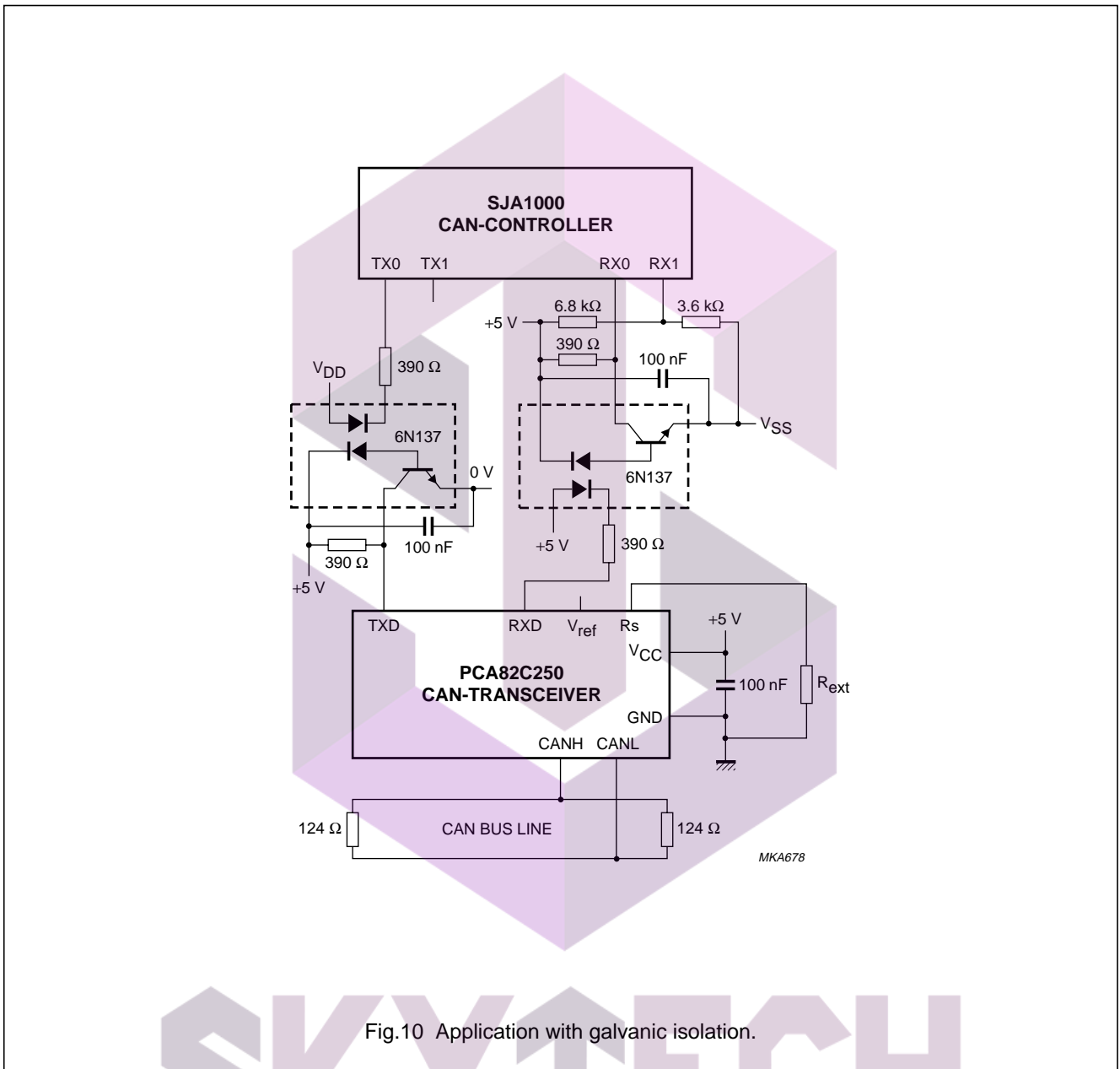

Fig.10 Application with galvanic isolation.

SKYTECH

تهیه و توزیع قطعات الکترونیک

CAN controller interface

PCA82C250

INTERNAL PIN CONFIGURATION

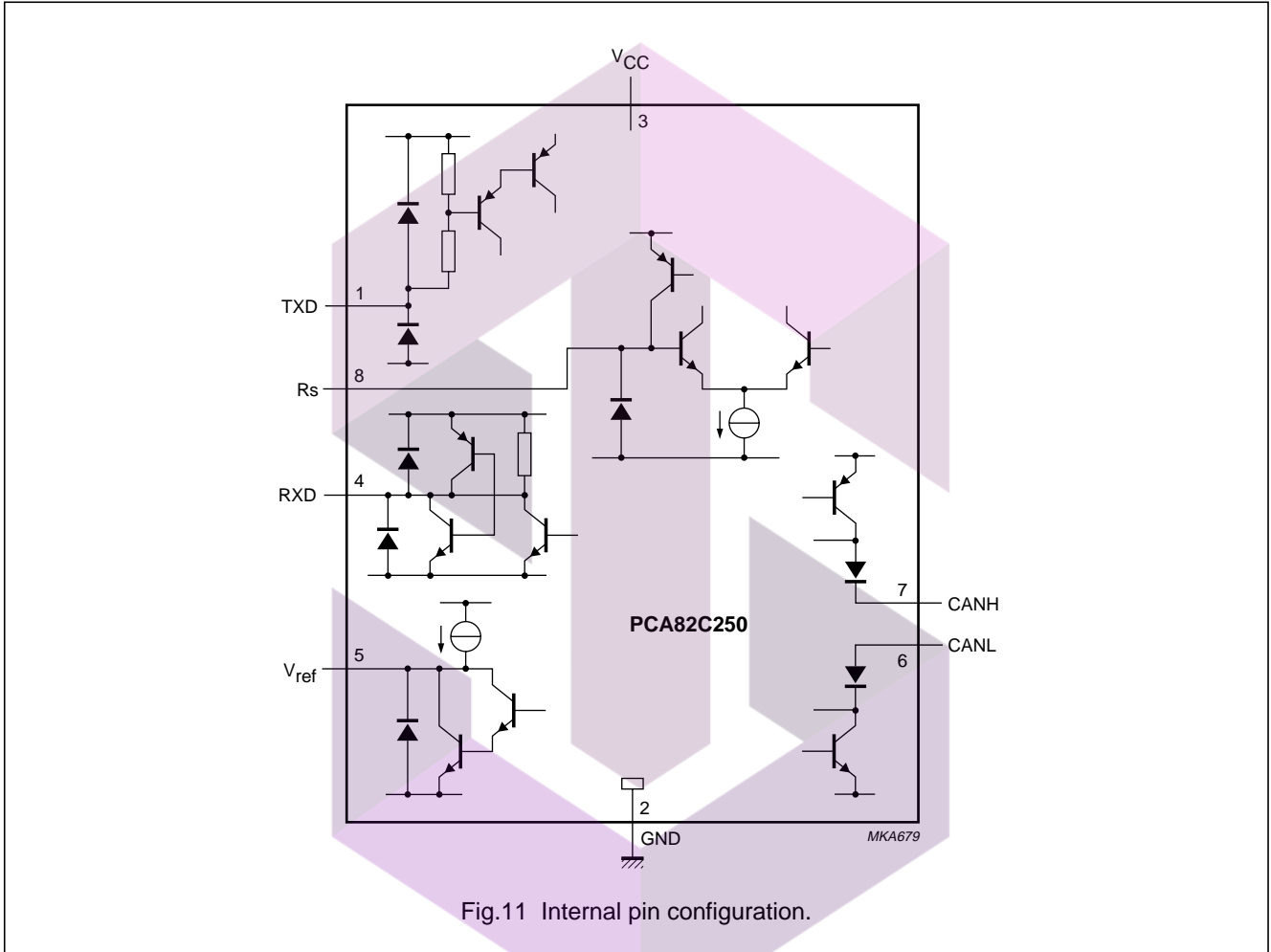

CAN controller interface

PCA82C250

BONDING PAD LOCATIONS

SYMBOL	PAD	COORDINATES ⁽¹⁾	
		x	y
TXD	1	196	135
GND	2	1280	135
V _{CC}	3	1767	135
RXD	4	2588	135
V _{ref}	5	2594	1640
CANL	6	1689	1640
CANH	7	948	1640
Rs	8	196	1640

Note

1. All coordinates (μm) represent the position of the centre of each pad with respect to the bottom left-hand corner of the die (x/y = 0).

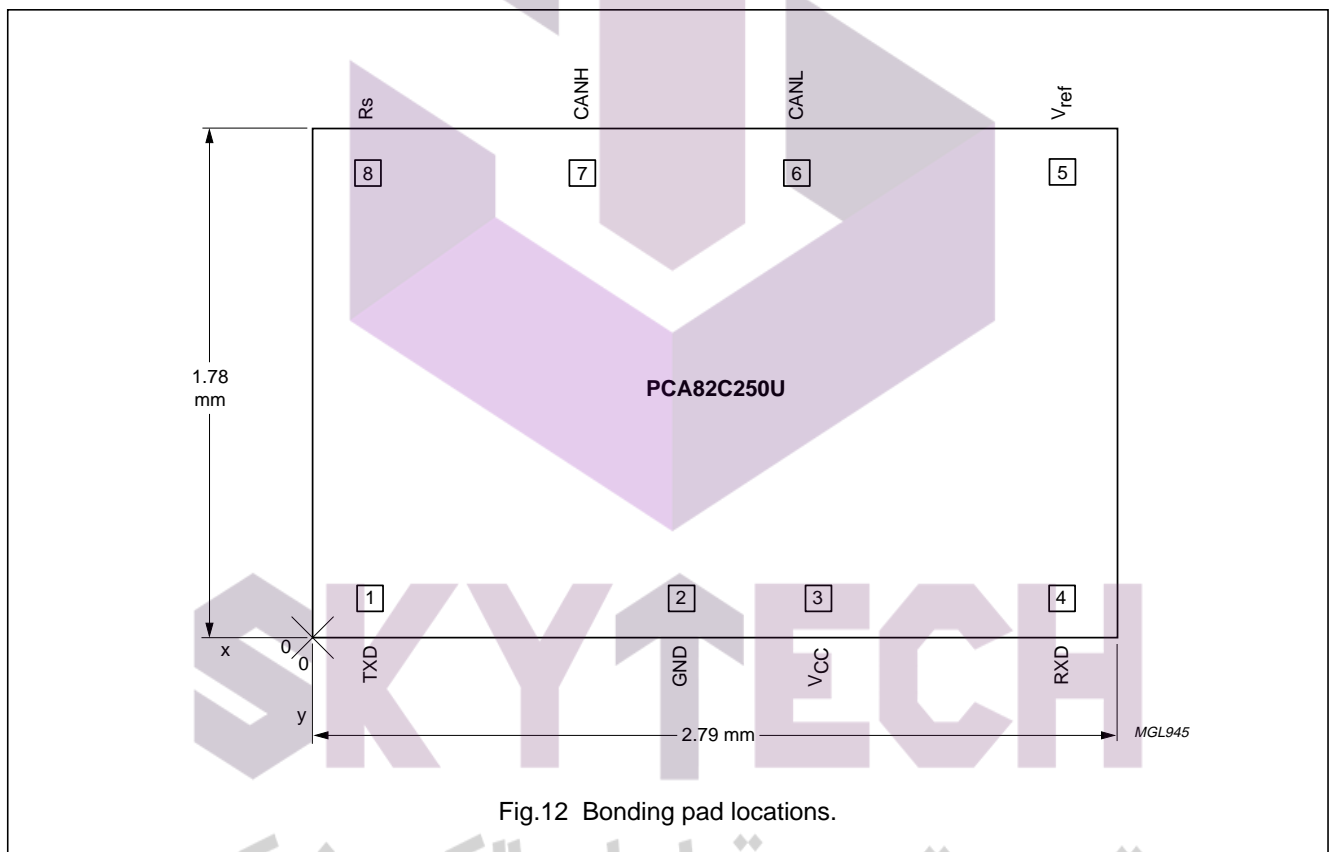

Fig.12 Bonding pad locations.

تهیه و توزیع قطعات الکترونیک

CAN controller interface

PCA82C250

PACKAGE OUTLINES

DIP8: plastic dual in-line package; 8 leads (300 mil)

SOT97-1

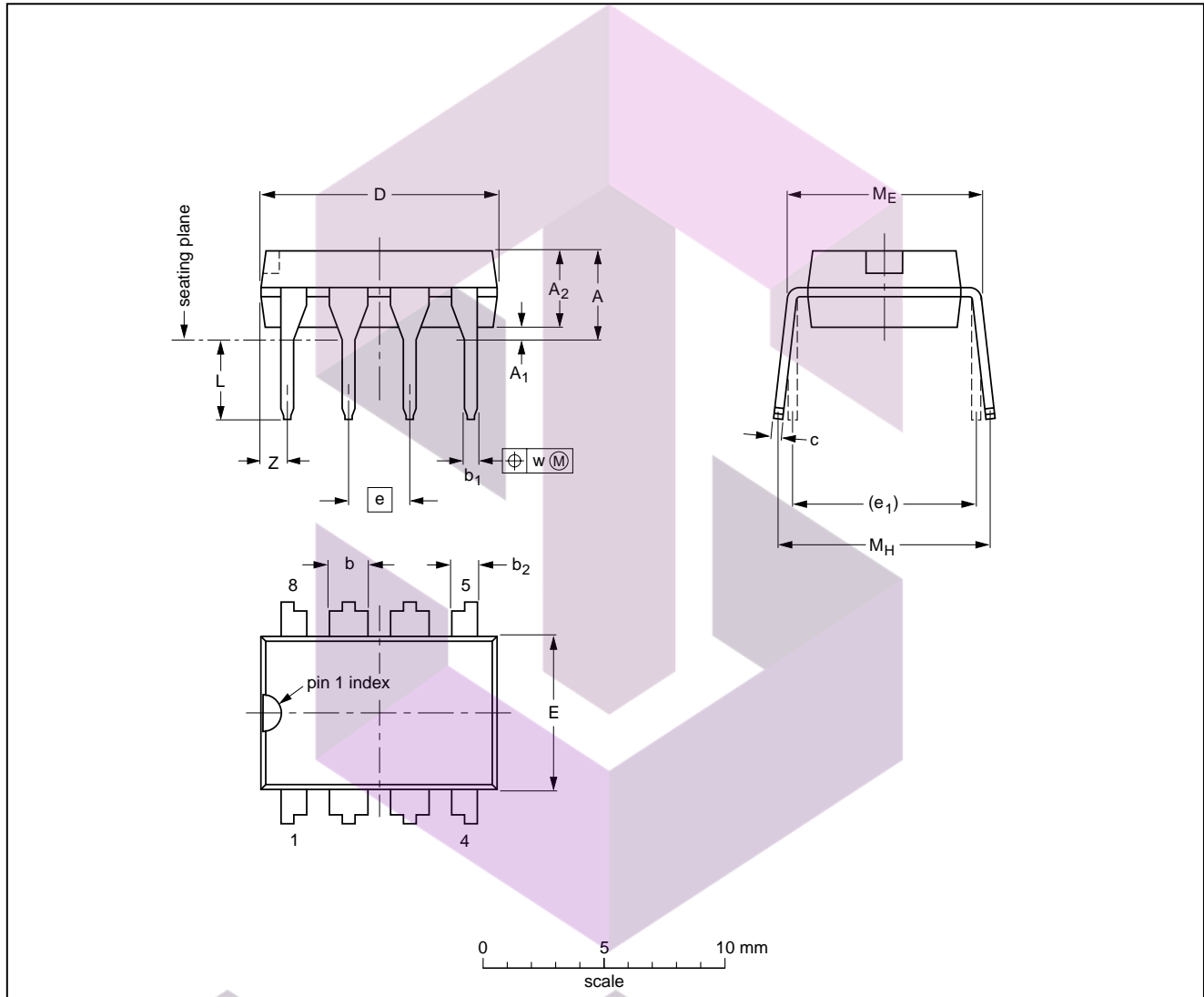

DIMENSIONS (inch dimensions are derived from the original mm dimensions)

UNIT	A max.	A ₁ min.	A ₂ max.	b	b ₁	b ₂	c	D ⁽¹⁾	E ⁽¹⁾	e	e ₁	L	M _E	M _H	w	Z ⁽¹⁾ max.
mm	4.2	0.51	3.2	1.73 1.14	0.53 0.38	1.07 0.89	0.36 0.23	9.8 9.2	6.48 6.20	2.54	7.62	3.60 3.05	8.25 7.80	10.0 8.3	0.254	1.15
inches	0.17	0.020	0.13	0.068 0.045	0.021 0.015	0.042 0.035	0.014 0.009	0.39 0.36	0.26 0.24	0.10	0.30	0.14 0.12	0.32 0.31	0.39 0.33	0.01	0.045

Note

1. Plastic or metal protrusions of 0.25 mm maximum per side are not included.

OUTLINE VERSION	REFERENCES			EUROPEAN PROJECTION	ISSUE DATE
	IEC	JEDEC	EIAJ		
SOT97-1	050G01	MO-001	SC-504-8		95-02-04 99-12-27

CAN controller interface

PCA82C250

SO8: plastic small outline package; 8 leads; body width 3.9 mm

SOT96-1

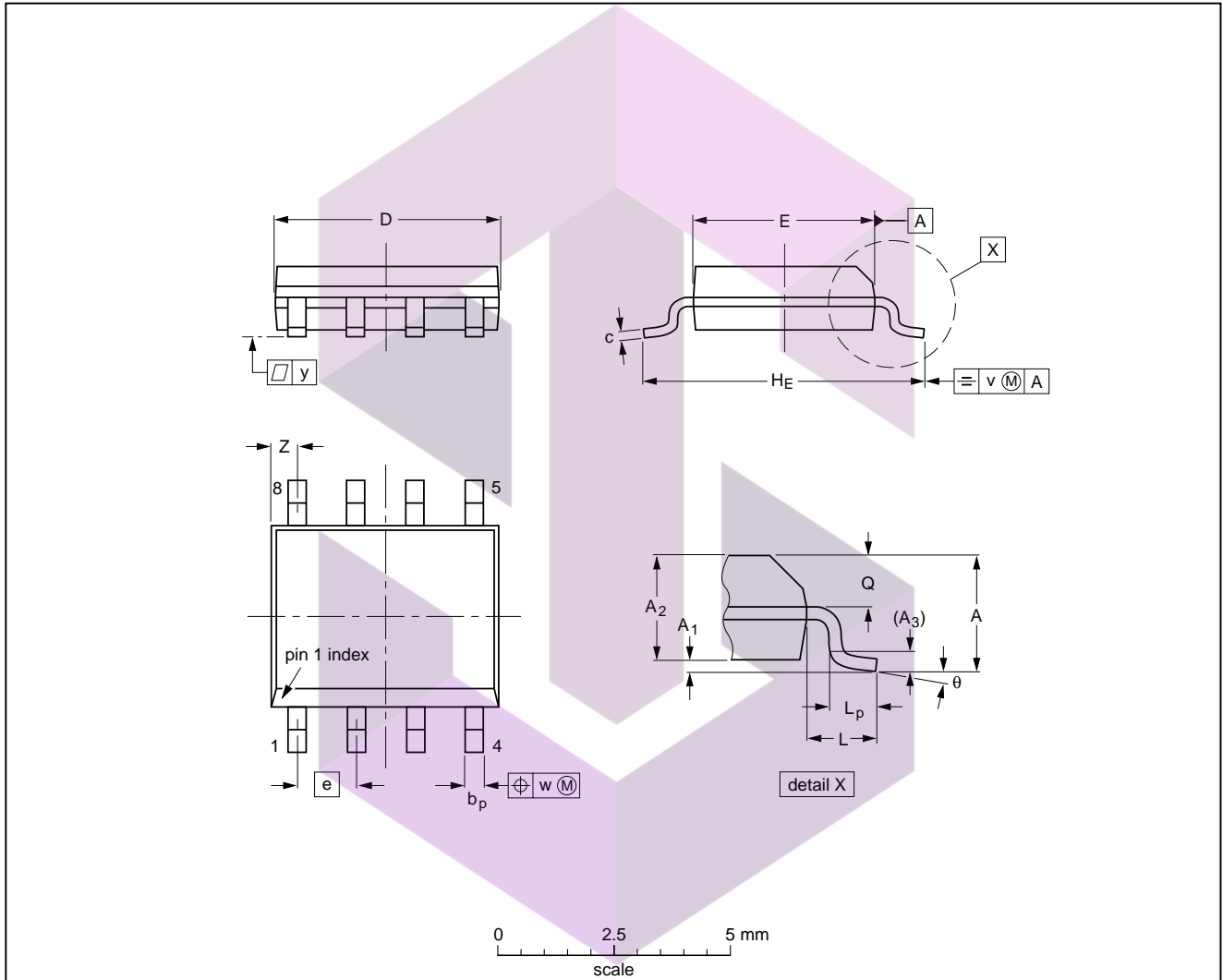

DIMENSIONS (inch dimensions are derived from the original mm dimensions)

UNIT	A max.	A ₁	A ₂	A ₃	b _p	c	D ⁽¹⁾	E ⁽²⁾	e	H _E	L	L _p	Q	v	w	y	z ⁽¹⁾	θ
mm	1.75	0.25 0.10	1.45 1.25	0.25	0.49 0.36	0.25 0.19	5.0 4.8	4.0 3.8	1.27	6.2 5.8	1.05	1.0 0.4	0.7 0.6	0.25	0.25	0.1	0.7 0.3	8° 0°
inches	0.069	0.010 0.004	0.057 0.049	0.01	0.019 0.014	0.0100 0.0075	0.20 0.19	0.16 0.15	0.050	0.244 0.228	0.041	0.039 0.016	0.028 0.024	0.01	0.01	0.004	0.028 0.012	

Notes

1. Plastic or metal protrusions of 0.15 mm maximum per side are not included.
2. Plastic or metal protrusions of 0.25 mm maximum per side are not included.

OUTLINE VERSION	REFERENCES			EUROPEAN PROJECTION	ISSUE DATE
	IEC	JEDEC	EIAJ		
SOT96-1	076E03	MS-012			97-05-22 99-12-27

CAN controller interface

PCA82C250

SOLDERING**Introduction**

This text gives a very brief insight to a complex technology. A more in-depth account of soldering ICs can be found in our "Data Handbook IC26; Integrated Circuit Packages" (document order number 9398 652 90011).

There is no soldering method that is ideal for all IC packages. Wave soldering is often preferred when through-hole and surface mount components are mixed on one printed-circuit board. However, wave soldering is not always suitable for surface mount ICs, or for printed-circuit boards with high population densities. In these situations reflow soldering is often used.

Through-hole mount packages**SOLDERING BY DIPPING OR BY SOLDER WAVE**

The maximum permissible temperature of the solder is 260 °C; solder at this temperature must not be in contact with the joints for more than 5 seconds. The total contact time of successive solder waves must not exceed 5 seconds.

The device may be mounted up to the seating plane, but the temperature of the plastic body must not exceed the specified maximum storage temperature ($T_{stg(max)}$). If the printed-circuit board has been pre-heated, forced cooling may be necessary immediately after soldering to keep the temperature within the permissible limit.

MANUAL SOLDERING

Apply the soldering iron (24 V or less) to the lead(s) of the package, either below the seating plane or not more than 2 mm above it. If the temperature of the soldering iron bit is less than 300 °C it may remain in contact for up to 10 seconds. If the bit temperature is between 300 and 400 °C, contact may be up to 5 seconds.

Surface mount packages**REFLOW SOLDERING**

Reflow soldering requires solder paste (a suspension of fine solder particles, flux and binding agent) to be applied to the printed-circuit board by screen printing, stencilling or pressure-syringe dispensing before package placement.

Several methods exist for reflowing; for example, infrared/convection heating in a conveyor type oven. Throughput times (preheating, soldering and cooling) vary between 100 and 200 seconds depending on heating method.

Typical reflow peak temperatures range from 215 to 250 °C. The top-surface temperature of the packages should preferably be kept below 230 °C.

WAVE SOLDERING

Conventional single wave soldering is not recommended for surface mount devices (SMDs) or printed-circuit boards with a high component density, as solder bridging and non-wetting can present major problems.

To overcome these problems the double-wave soldering method was specifically developed.

If wave soldering is used the following conditions must be observed for optimal results:

- Use a double-wave soldering method comprising a turbulent wave with high upward pressure followed by a smooth laminar wave.
- For packages with leads on two sides and a pitch (e):
 - larger than or equal to 1.27 mm, the footprint longitudinal axis is **preferred** to be parallel to the transport direction of the printed-circuit board;
 - smaller than 1.27 mm, the footprint longitudinal axis **must** be parallel to the transport direction of the printed-circuit board.

The footprint must incorporate solder thieves at the downstream end.

- For packages with leads on four sides, the footprint must be placed at a 45° angle to the transport direction of the printed-circuit board. The footprint must incorporate solder thieves downstream and at the side corners.

During placement and before soldering, the package must be fixed with a droplet of adhesive. The adhesive can be applied by screen printing, pin transfer or syringe dispensing. The package can be soldered after the adhesive is cured.

Typical dwell time is 4 seconds at 250 °C.

A mildly-activated flux will eliminate the need for removal of corrosive residues in most applications.

MANUAL SOLDERING

Fix the component by first soldering two diagonally-opposite end leads. Use a low voltage (24 V or less) soldering iron applied to the flat part of the lead. Contact time must be limited to 10 seconds at up to 300 °C.

When using a dedicated tool, all other leads can be soldered in one operation within 2 to 5 seconds between 270 and 320 °C.

CAN controller interface

PCA82C250

Suitability of IC packages for wave, reflow and dipping soldering methods

MOUNTING	PACKAGE	SOLDERING METHOD		
		WAVE	REFLOW ⁽¹⁾	DIPPING
Through-hole mount	DBS, DIP, HDIP, SDIP, SIL	suitable ⁽²⁾	–	suitable
Surface mount	BGA, LFBGA, SQFP, TFBGA	not suitable	suitable	–
	HBCC, HLQFP, HSQFP, HSOP, HTQFP, HTSSOP, SMS	not suitable ⁽³⁾	suitable	–
	PLCC ⁽⁴⁾ , SO, SOJ	suitable	suitable	–
	LQFP, QFP, TQFP	not recommended ⁽⁴⁾⁽⁵⁾	suitable	–
	SSOP, TSSOP, VSO	not recommended ⁽⁶⁾	suitable	–

Notes

1. All surface mount (SMD) packages are moisture sensitive. Depending upon the moisture content, the maximum temperature (with respect to time) and body size of the package, there is a risk that internal or external package cracks may occur due to vaporization of the moisture in them (the so called popcorn effect). For details, refer to the Drypack information in the “*Data Handbook IC26; Integrated Circuit Packages; Section: Packing Methods*”.
2. For SDIP packages, the longitudinal axis must be parallel to the transport direction of the printed-circuit board.
3. These packages are not suitable for wave soldering as a solder joint between the printed-circuit board and heatsink (at bottom version) can not be achieved, and as solder may stick to the heatsink (on top version).
4. If wave soldering is considered, then the package must be placed at a 45° angle to the solder wave direction. The package footprint must incorporate solder thieves downstream and at the side corners.
5. Wave soldering is only suitable for LQFP, QFP and TQFP packages with a pitch (e) equal to or larger than 0.8 mm; it is definitely not suitable for packages with a pitch (e) equal to or smaller than 0.65 mm.
6. Wave soldering is only suitable for SSOP and TSSOP packages with a pitch (e) equal to or larger than 0.65 mm; it is definitely not suitable for packages with a pitch (e) equal to or smaller than 0.5 mm.



تهیه و توزیع قطعات الکترونیک

CAN controller interface

PCA82C250

DEFINITIONS

Data sheet status	
Objective specification	This data sheet contains target or goal specifications for product development.
Preliminary specification	This data sheet contains preliminary data; supplementary data may be published later.
Product specification	This data sheet contains final product specifications.
Limiting values	
Limiting values given are in accordance with the Absolute Maximum Rating System (IEC 134). Stress above one or more of the limiting values may cause permanent damage to the device. These are stress ratings only and operation of the device at these or at any other conditions above those given in the Characteristics sections of the specification is not implied. Exposure to limiting values for extended periods may affect device reliability.	
Application information	
Where application information is given, it is advisory and does not form part of the specification.	

LIFE SUPPORT APPLICATIONS

These products are not designed for use in life support appliances, devices, or systems where malfunction of these products can reasonably be expected to result in personal injury. Philips customers using or selling these products for use in such applications do so at their own risk and agree to fully indemnify Philips for any damages resulting from such improper use or sale.

BARE DIE DISCLAIMER

All die are tested and are guaranteed to comply with all data sheet limits up to the point of wafer sawing for a period of ninety (90) days from the date of Philips' delivery. If there are data sheet limits not guaranteed, these will be separately indicated in the data sheet. There are no post packing tests performed on individual die or wafer. Philips Semiconductors has no control of third party procedures in the sawing, handling, packing or assembly of the die. Accordingly, Philips Semiconductors assumes no liability for device functionality or performance of the die or systems after third party sawing, handling, packing or assembly of the die. It is the responsibility of the customer to test and qualify their application in which the die is used.



Philips Semiconductors – a worldwide company

Argentina: see South America

Australia: 3 Figtree Drive, HOMEBUSH, NSW 2140,
Tel. +61 2 9704 8141, Fax. +61 2 9704 8139

Austria: Computerstr. 6, A-1101 WIEN, P.O. Box 213,
Tel. +43 1 60 101 1248, Fax. +43 1 60 101 1210

Belarus: Hotel Minsk Business Center, Bld. 3, r. 1211, Volodarski Str. 6,
220050 MINSK, Tel. +375 172 20 0733, Fax. +375 172 20 0773

Belgium: see The Netherlands

Brazil: see South America

Bulgaria: Philips Bulgaria Ltd., Energoproject, 15th floor,
51 James Bourchier Blvd., 1407 SOFIA,
Tel. +359 2 68 9211, Fax. +359 2 68 9102

Canada: PHILIPS SEMICONDUCTORS/COMPONENTS,
Tel. +1 800 234 7381, Fax. +1 800 943 0087

China/Hong Kong: 501 Hong Kong Industrial Technology Centre,
72 Tat Chee Avenue, Kowloon Tong, HONG KONG,
Tel. +852 2319 7888, Fax. +852 2319 7700

Colombia: see South America

Czech Republic: see Austria

Denmark: Sydhavnsgade 23, 1780 COPENHAGEN V,
Tel. +45 33 29 3333, Fax. +45 33 29 3905

Finland: Sinikalliontie 3, FIN-02630 ESPOO,
Tel. +358 9 615 800, Fax. +358 9 6158 0920

France: 51 Rue Carnot, BP317, 92156 SURESNES Cedex,
Tel. +33 1 4099 6161, Fax. +33 1 4099 6427

Germany: Hammerbrookstraße 69, D-20097 HAMBURG,
Tel. +49 40 2353 60, Fax. +49 40 2353 6300

Hungary: see Austria

India: Philips INDIA Ltd, Band Box Building, 2nd floor,
254-D, Dr. Annie Besant Road, Worli, MUMBAI 400 025,
Tel. +91 22 493 8541, Fax. +91 22 493 0966

Indonesia: PT Philips Development Corporation, Semiconductors Division,
Gedung Philips, Jl. Buncit Raya Kav.99-100, JAKARTA 12510,
Tel. +62 21 794 0040 ext. 2501, Fax. +62 21 794 0080

Ireland: Newstead, Clonskeagh, DUBLIN 14,
Tel. +353 1 7640 000, Fax. +353 1 7640 200

Israel: RAPAC Electronics, 7 Kehilat Saloniki St, PO Box 18053,
TEL AVIV 61180, Tel. +972 3 645 0444, Fax. +972 3 649 1007

Italy: PHILIPS SEMICONDUCTORS, Via Casati, 23 - 20052 MONZA (MI),
Tel. +39 039 203 6838, Fax +39 039 203 6800

Japan: Philips Bldg 13-37, Kohnan 2-chome, Minato-ku,
TOKYO 108-8507, Tel. +81 3 3740 5130, Fax. +81 3 3740 5057

Korea: Philips House, 260-199 Itaewon-dong, Yongsan-ku, SEOUL,
Tel. +82 2 709 1412, Fax. +82 2 709 1415

Malaysia: No. 76 Jalan Universiti, 46200 PETALING JAYA, SELANGOR,
Tel. +60 3 750 5214, Fax. +60 3 757 4880

Mexico: 5900 Gateway East, Suite 200, EL PASO, TEXAS 79905,
Tel. +9-5 800 234 7381, Fax +9-5 800 943 0087

Middle East: see Italy

Netherlands: Postbus 90050, 5600 PB EINDHOVEN, Bldg. VB,
Tel. +31 40 27 82785, Fax. +31 40 27 88399

New Zealand: 2 Wagener Place, C.P.O. Box 1041, AUCKLAND,
Tel. +64 9 849 4160, Fax. +64 9 849 7811

Norway: Box 1, Manglerud 0612, OSLO,
Tel. +47 22 74 8000, Fax. +47 22 74 8341

Pakistan: see Singapore

Philippines: Philips Semiconductors Philippines Inc.,
106 Valero St. Salcedo Village, P.O. Box 2108 MCC, MAKATI,
Metro MANILA, Tel. +63 2 816 6380, Fax. +63 2 817 3474

Poland: Al.Jerozolimskie 195 B, 02-222 WARSAW,
Tel. +48 22 5710 000, Fax. +48 22 5710 001

Portugal: see Spain

Romania: see Italy

Russia: Philips Russia, Ul. Usatcheva 35A, 119048 MOSCOW,
Tel. +7 095 755 6918, Fax. +7 095 755 6919

Singapore: Lorong 1, Toa Payoh, SINGAPORE 319762,
Tel. +65 350 2538, Fax. +65 251 6500

Slovakia: see Austria

Slovenia: see Italy

South Africa: S.A. PHILIPS Pty Ltd., 195-215 Main Road Martindale,
2092 JOHANNESBURG, P.O. Box 58088 Newville 2114,
Tel. +27 11 471 5401, Fax. +27 11 471 5398

South America: Al. Vicente Pinzon, 173, 6th floor,
04547-130 SÃO PAULO, SP, Brazil,
Tel. +55 11 821 2333, Fax. +55 11 821 2382

Spain: Balmes 22, 08007 BARCELONA,
Tel. +34 93 301 6312, Fax. +34 93 301 4107

Sweden: Kottbygatan 7, Akalla, S-16485 STOCKHOLM,
Tel. +46 8 5985 2000, Fax. +46 8 5985 2745

Switzerland: Allmendstrasse 140, CH-8027 ZÜRICH,
Tel. +41 1 488 2741 Fax. +41 1 488 3263

Taiwan: Philips Semiconductors, 6F, No. 96, Chien Kuo N. Rd., Sec. 1,
TAIPEI, Taiwan Tel. +886 2 2134 2886, Fax. +886 2 2134 2874

Thailand: PHILIPS ELECTRONICS (THAILAND) Ltd.,
209/2 Sanpavuth-Bangna Road Prakanong, BANGKOK 10260,
Tel. +66 2 745 4090, Fax. +66 2 398 0793

Turkey: Yukari Dudullu, Org. San. Blg., 2.Cad. Nr. 28 81260 Umraniye,
ISTANBUL, Tel. +90 216 522 1500, Fax. +90 216 522 1813

Ukraine: PHILIPS UKRAINE, 4 Patrice Lumumba str., Building B, Floor 7,
252042 KIEV, Tel. +380 44 264 2776, Fax. +380 44 268 0461

United Kingdom: Philips Semiconductors Ltd., 276 Bath Road, Hayes,
MIDDLESEX UB3 5BX, Tel. +44 208 730 5000, Fax. +44 208 754 8421

United States: 811 East Arques Avenue, SUNNYVALE, CA 94088-3409,
Tel. +1 800 234 7381, Fax. +1 800 943 0087

Uruguay: see South America

Vietnam: see Singapore

Yugoslavia: PHILIPS, Trg N. Pasica 5/v, 11000 BEOGRAD,
Tel. +381 11 3341 299, Fax.+381 11 3342 553

For all other countries apply to: Philips Semiconductors,
International Marketing & Sales Communications, Building BE-p, P.O. Box 218,
5600 MD EINDHOVEN, The Netherlands, Fax. +31 40 27 24825

Internet: <http://www.semiconductors.philips.com>

© Philips Electronics N.V. 2000

SCA 69

All rights are reserved. Reproduction in whole or in part is prohibited without the prior written consent of the copyright owner.

The information presented in this document does not form part of any quotation or contract, is believed to be accurate and reliable and may be changed without notice. No liability will be accepted by the publisher for any consequence of its use. Publication thereof does not convey nor imply any license under patent- or other industrial or intellectual property rights.

Printed in The Netherlands

285002/05/pp20

Date of release: 2000 Jan 13

Document order number: 9397 750 06609

تهیه و توزیع قطعات الکترونیک
Let's make things better.

Philips
Semiconductors



PHILIPS